



FLEXIBLE CONNECTORS

FLEX-ING™ brand flexible connectors have become the industry standard and benchmark for quality as a means to easily connect a pipework system to other system components such as submersible pumps or shear valves. As an integral part of any system, installers enjoy how easy they make connections in tight spaces while station owners have come to depend on their durability and their simplification of regular maintenance. End fittings are available in either nickel plated steel or stainless steel construction. FLEX-ING™ flexible connectors offer multiple diameter and length options as well as a wide offering of end fitting connections so you can create the right flexible connector to fit virtually any application.

HIGHLIGHTS

- Standard on all flexible connectors, the stainless steel corrugated fuel contact layers feature a thick construction and gain flexibility from having more corrugations per foot rather than thinner walls.
- Enclosing the corrugated fuel contact layer is a stainless steel braid that is manufactured from only high-grade stainless steel.
- Standard end fittings are nickel plated steel with stainless steel construction options available on any flexible connector that does not include a swivel end fitting.
- Available in a multitude of end connections to ensure the right fit for any application - including tees, elbows, and fiberglass transitions.
- All metal construction means one flexible connector for both above and below ground applications (may not be direct buried).
- Schedule 80 hex end fittings protect against deformation of the ends during installation.
- The EZ FIT union style coupling system is specifically designed to make connections in confined spaces simple and tight.
- EZ FIT union style couplings come complete with couplers and gaskets (flange only fittings excluded).

SPECIFICATIONS

- Meets USA NFPA 30-A fire code requirements.
- Outer shell: 304 stainless steel
- Inner core: 321 stainless steel
- End fittings: Nickel plated steel or stainless steel.
- 100% pressure tested to 100 PSI to assure quality.

Approvals/Certifications

- UL 2039 listed for above and below ground installation for use with gasoline, gas alcohol blends (up to E85), diesel, and Biodiesel.
- UL 2039 approved for 50 psi working pressure.

End Fitting Options

- | | |
|------------------------------|-------------------------------|
| 1 EZ Fit flange only* | 8 Hex female fixed (NPT)* |
| 2 EZ Fit male* | 9 Hex male fixed (BSPT)* |
| 3 EZ Fit female* | 10 Hex male swivel (BSPT)* |
| 4 EZ Fit fiberglass (glued)* | 11 90° male swivel |
| 5 Male swivel | 12 EZ Fit tee flanges only* |
| 6 Female swivel | 13 Flat faced round flange* |
| 7 Hex male fixed (NPT)* | 14 Raised faced round flange* |

*Also available in stainless steel.



ORDERING INFORMATION

Use the diagrams below along with the Ordering Guide at the bottom to help you build your flexible connector model numbers.

Ordering Options Diagram

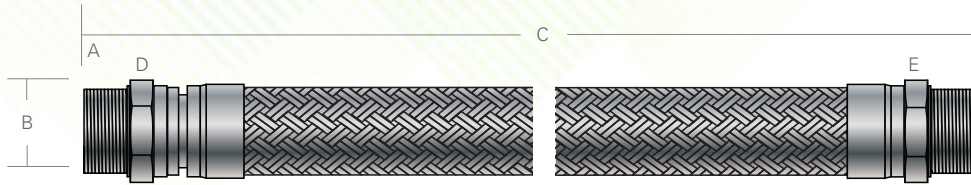

End Fitting Options

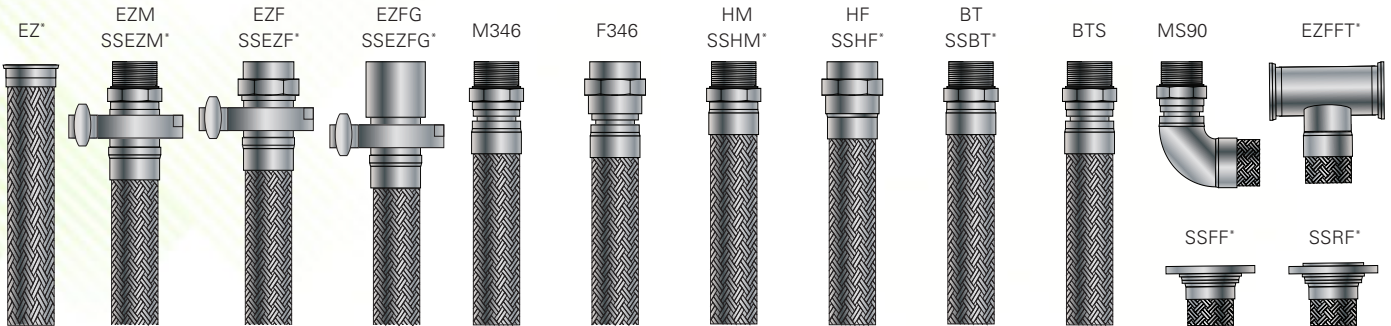

*These models feature full stainless steel construction.

Ordering Guide

Complete flexible connector part numbers have a specific order and are created using the following guidelines. Please note that full stainless steel models are available on any flexible connector that does not include swivel end fittings.

A B X C D X E

A = Product Type

FF = If either of the end connections are any type of swivel or EZ Fit, this option must be selected.

FFUL = If both end connections are fixed (non-swivel or EZ Fit), this option must be selected.

B = Hose Diameter

07 = ¾"

10 = 1"

15 = 1½"

20 = 2"

30 = 3"

40 = 4"

C = Overall Length in Inches

Use two-digit format

D & E = End Fitting Options (non-swivel options available in stainless steel)

EZ = EZ FIT flange only (stainless steel only)

EZM = EZ FIT male NPT (SSEZM = stainless steel)

EZF = EZ FIT female NPT (SSEZF = stainless steel)

EZFG = EZ FIT fiberglass glue pipe (SSEZFG = stainless steel)

M346 = Male swivel NPT

F346 = Female swivel NPT

HM = Hex male fixed NPT (SSHM = stainless steel)

HF = Hex female fixed NPT (SSHF = stainless steel)

BT = Hex male fixed BSPT (SSBT = stainless steel)

BTS = Male swivel BSPT

MS90 = 90° with male swivel NPT

EZFFT = EZ Fit Tee (stainless steel only)

SSFF = Flat faced round flange (stainless steel only)

SSRF = Raised faced round flange (stainless steel only)

NOTE: Each EZ FIT union style coupling comes complete with couplers and gaskets.

Examples:

FF20X18M346XHM = Flexible connector with swivel end fitting(s), 2" hose diameter, 18" overall length, with one male swivel end fitting and one fixed Hex male end fitting.

FF20X18SSEZMXSSHM = Flexible connector, 2" hose diameter, 18" overall length, with one stainless steel EZ Fit male end fitting and one stainless steel fixed hex male end fitting, full stainless steel construction.

Flexible Connectors with Differing Hose and End Fitting Diameters

All end fittings are, by default, the same diameter as the hose. If you require a flexible connector where the end fitting diameter does not match the hose diameter, the size must be indicated numerically in front of the corresponding fitting as in the following example.

Example: FFUL15X18HMX2HM = Flexible connector with fixed end fittings, 1½" hose diameter, 18" overall length, with one 1½" hex male fixed end fitting, and one 2" hex male fixed end fitting.

Rules:

- 1) End fitting diameters can not be smaller than hose diameters.
- 2) Only one hose fitting per flexible connector can be of a different diameter than the hose diameter.
- 3) End fitting diameter must only be one size larger than hose (1" hose could use 1½" fitting, 1½" hose could use 2" fitting, etc.).
- 4) EZ Fit end fittings are available in 1", 2", and 3" only.
- 5) Additional end fitting types are available. Please contact Customer Service with inquiries.

ORDERING INFORMATION CONTINUED

Flexible Connector Common Configurations (Nickel Plated Steel End Fittings)

All include NPT threads unless otherwise specified as BSPT.

Model	Description
FFUL15X18HMXHM	1½" diameter flexible connector, hex male by hex male, 18" OAL
FFUL20X18HMXHM	2" diameter flexible connector, hex male by hex male, 18" OAL
FF10X18HMXM346	1" diameter flexible connector, hex male by male swivel, 18" OAL
FF15X12BTXBTS	1½" diameter flexible connector, hex male (BSPT) by male swivel (BSPT), 12" OAL
FF15X12HMXM346	1½" diameter flexible connector, hex male by male swivel, 12" OAL
FF15X12M346X2F	1½" diameter flexible connector, male swivel by 2" hex female, 12" OAL
FF15X12M346XEZ	1½" diameter flexible connector, male swivel by EZ Fit flange only, 12" OAL
FF15X12SSHMXEZ	1½" diameter flexible connector, stainless steel hex male by EZ Fit flange only, 12" OAL
FF15X15HMXM346	1½" diameter flexible connector, hex male by male swivel, 15" OAL
FF15X16BTXBTS	1½" diameter flexible connector, hex male (BSPT) by male swivel (BSPT), 16" OAL
FF15X16HMXM346	1½" diameter flexible connector, hex male by male swivel, 16" OAL
FF15X18EZMXEZZFT	1½" diameter flexible connector, EZ Fit male by EZ Fit tee, 18" OAL
FF15X18EZMXEZM	1½" diameter flexible connector, EZ Fit male by EZ Fit male 18" OAL
FF15X18HMXEZM	1½" diameter flexible connector, hex male by EZ Fit male, 18" OAL
FF15X18HMXM346	1½" diameter flexible connector, hex male by male swivel, 18" OAL
FF15X18M346X2F	1½" diameter flexible connector, male swivel by 2" hex female, 18" OAL
FF15X18M346XEZM	1½" diameter flexible connector, male swivel by EZ Fit male, 18" OAL
FF15X24HMXM346	1½" diameter flexible connector, hex male by male swivel, 24" OAL
FF20X12HMXM346	2" diameter flexible connector, hex male by male swivel, 12" OAL
FF20X15HMXM346	2" diameter flexible connector, hex male by male swivel, 15" OAL
FF20X18HMXEZF	2" diameter flexible connector, hex male by EZ Fit female, 18" OAL
FF20X18HMXM346	2" diameter flexible connector, hex male by male swivel, 18" OAL
FF20X18M346XF	2" diameter flexible connector, male swivel by hex female, 18" OAL
FF20X24BTXBTS	2" diameter flexible connector, hex male (BSPT) by male swivel (BSPT), 24" OAL
FF20X24HMXM346	2" diameter flexible connector, hex male by male swivel, 24" OAL
FF20X24HMXMS90	2" diameter flexible connector, hex male by 90° male swivel, 24" OAL

Flexible Connector Common Configurations (Stainless Steel End Fittings)

All include NPT threads unless otherwise specified as BSPT.

Model	Description
FF15X12SSHMXSSH	1½" diameter stainless steel flexible connector, hex male by hex male, 12" OAL
FF15X18SSHMXSSH	1½" diameter stainless steel flexible connector, hex male by hex male, 18" OAL
FF15X24SSHMXSSH	1½" diameter stainless steel flexible connector, hex male by hex male, 24" OAL
FF15X12SSHMXEZ	1½" diameter stainless steel flexible connector, hex male by EZ Fit flange only, 12" OAL
FF15X18SSHMXEZ	1½" diameter stainless steel flexible connector, hex male by EZ Fit flange only, 18" OAL
FF15X24SSHMXEZ	1½" diameter stainless steel flexible connector, hex male by EZ Fit flange only, 24" OAL
FF15X12EZXSSSEZM	1½" diameter stainless steel flexible connector, EZ Fit male by EZ Fit flange only, 12" OAL
FF15X18EZXSSSEZM	1½" diameter stainless steel flexible connector, EZ Fit male by EZ Fit flange only, 18" OAL
FF15X24EZXSSSEZM	1½" diameter stainless steel flexible connector, EZ Fit male by EZ Fit flange only, 24" OAL
FF15X18SSHMXSSSEZM	1½" diameter stainless steel flexible connector, hex male by EZ Fit male, 18" OAL
FF20X12SSHMXSSH	2" diameter stainless steel flexible connector, hex male by hex male, 12" OAL
FF20X18SSHMXSSH	2" diameter stainless steel flexible connector, hex male by hex male, 18" OAL
FF20X12SSHMXEZ	2" diameter stainless steel flexible connector, hex male by EZ Fit flange only, 12" OAL
FF20X18SSHMXEZ	2" diameter stainless steel flexible connector, hex male by EZ Fit flange only, 18" OAL
FF20X12EZXSSSEZM	2" diameter stainless steel flexible connector, EZ Fit male by EZ Fit flange only, 12" OAL
FF20X18EZXSSSEZM	2" diameter stainless steel flexible connector, EZ Fit male by EZ Fit flange only, 18" OAL
FF20X12SSHMXSSSEZM	2" diameter stainless steel flexible connector, hex male by EZ Fit male, 12" OAL
FF20X18SSHMXSSSEZM	2" diameter stainless steel flexible connector, hex male by EZ Fit male, 18" OAL

ORDERING INFORMATION CONTINUED

EZ Fit Accessories



Model	Description
EZFITXEZFIT	2" EZ Fit × EZ Fit connector, stainless steel



Model	Description
EZBLANK	2" EZ Fit blank, stainless steel
EZ30BLANK	3" EZ Fit blank, stainless steel

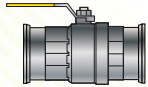

Model	Description
EZXEXZ20BV	2" EZ Fit × 2" EZ Fit ball valve
EZX20BV	2" EZ Fit × 2" ball valve, brass
EZXEXZ20BVSS	2" EZ Fit × 2" EZ Fit ball valve, stainless steel
EZX20BVSS	2" EZ Fit × 2" ball valve, stainless steel
EZ30XEZ30X30BV	3" EZ Fit × 3" EZ Fit ball valve, brass
EZ30XEZ30X30BVSS	3" EZ Fit × 3" EZ Fit ball valve, stainless steel

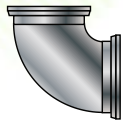
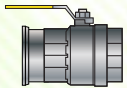

Model	Description
EZXEZ90	2" EZ Fit × 2" EZ Fit 90° elbow, stainless steel
EZ30XEZ3090	3" EZ Fit × 3" EZ Fit 90° elbow, stainless steel

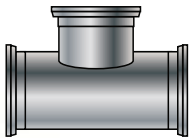

Model	Description
EZXEXEZTEE	2" EZ Fit × 2" EZ Fit × 2" EZ Fit 1½" tee, stainless steel
EZ30XEZ30XEZ30T	3" EZ Fit × 3" EZ Fit × 3" EZ Fit tee, stainless steel
EZ20XEZ20TEEFF	2" EZ Fit × 2" EZ Fit × 2" EZ Fit, 2" tee, stainless steel

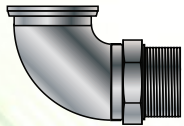

Model	Description
EZX15HM90	2" EZ Fit × 1½" hex male 90° elbow, nickel plated
EZX20HM90	2" EZ Fit × 2" hex male 90° elbow, nickel plated
EZX20HM90SS	2" EZ Fit × 2" hex male 90° elbow, stainless steel
EZX30M90	3" EZ Fit × 3" male 90° elbow, nickel plated

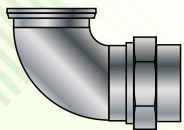

Model	Description
EZX20HF90	2" EZ Fit × 2" female 90° elbow, nickel plated
EZX30F90	3" EZ Fit × 3" female 90° elbow, nickel plated

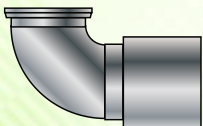

Model	Description
EZX20FG90	2" EZ Fit × 2" fiberglass glue pipe 90° elbow, nickel plated
EZX30FG90	3" EZ Fit × 3" fiberglass glue pipe 90° elbow, nickel plated

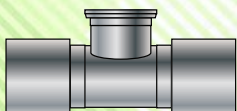

Model	Description
EZX20FGTEE	2" EZ Fit × 2" fiberglass glue pipe tee, nickel plated
EZX30FGTEE	3" EZ Fit × 3" fiberglass glue pipe tee, nickel plated

franklinfueling.com
 3760 Marsh Rd. • Madison, WI 53718, USA
 Tel: +1 608 838 8786 • Fax: +1 608 838 6433
 Tel: USA & Canada +1 800 225 9787 • Tel: UK +44 (0) 1473 243300
 Tel: Mex 001 800 738 7610 • Tel: FR +33 (0) 1 69 21 41 41 • Tel: CH +86 10 8565 4566



ORDERING INFORMATION CONTINUED



Model	Description
EZX15HMPL	2" EZ Fit x 1 1/2" hex male, nickel plated
EZX15HMSS	2" EZ Fit x 1 1/2" hex male, stainless steel
EZX20HMPL	2" EZ Fit x 2" hex male, nickel plated
EZX20HMSS	2" EZ Fit x 2" hex male, stainless steel
EZX30MP	3" EZ Fit x 3" male, nickel plated

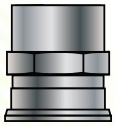

Model	Description
EZX15HFSS	2" EZ Fit x 1 1/2" hex female, stainless steel
EZX20HFPL	2" EZ Fit x 2" hex female, nickel plated
EZX20HFSS	2" EZ Fit x 2" hex female, stainless steel

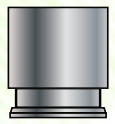

Model	Description
EZX20FGPL	2" EZ Fit x 2" fiberglass glue pipe, nickel plated
EZX20FGSS	2" EZ Fit x 2" fiberglass glue pipe, stainless steel
EZX30FGPL	3" EZ Fit x 3" fiberglass glue pipe, nickel plated



Model	Description
EZ10CLAMP	1" EZ Fit clamp
EZCLAMP	2" EZ Fit clamp
EZ30CLAMP	3" EZ Fit clamp



Model	Description
407493001	1" EZ Fit gasket
407493002	2" EZ Fit gasket
407493003	3" EZ Fit gasket